

ASSESSMENT OF THE MARS HELICOPTER THERMAL DESIGN SENSITIVITIES USING THE VERITREK SOFTWARE

Stefano Cappucci and Michael T. Pauken

Jet Propulsion Laboratory, California Institute of Technology, Pasadena, CA 91109

Jacob A. Moulton and Derek W. Hengeveld

LoadPath, Albuquerque, NM 87106

ABSTRACT

The Mars Helicopter will be a technology demonstration conducted during the Mars 2020 mission. The primary mission objective is to achieve several 90-second flights and capture visible light images via forward and nadir mounted cameras. These flights could possibly provide reconnaissance data for sampling site selection for other Mars surface missions. The helicopter is powered by a solar array, which stores energy in secondary batteries for flight operations, imaging, communications, and survival heating. The helicopter thermal design is driven by minimizing survival heater energy while maintaining compliance with allowable flight temperatures in a variable thermal environment. Due to the small size of the helicopter and its complex geometries, along with the fact that it operates with very low power and small margins, additional care had to be paid while planning thermal tests and designing the thermal system. A Thermal Desktop® model has been developed to predict the thermal system's performance. A reduced-order model (ROM) created with the Veritrek software has been utilized to explore the sensitivities of the thermal system's drivers, such as electronics dissipations, gas gaps, heat transfer coefficients, etc., as well as to assess and verify the final thermal design. This paper presents the performance of the Veritrek software products and the details of the ROM creation process. The results produced by Veritrek were utilized to study the effect of the major thermal design drivers and Mars environment on the Mars Helicopter in as little as 10 days, an effort that would have taken over 4 months using traditional thermal analysis techniques.

INTRODUCTION

The Mars Helicopter is a class D technology demonstration concept being developed in collaboration between the NASA Jet Propulsion Laboratory (Caltech/JPL) and AeroVironment, Inc. (AV). AV is delivering the propulsion hardware (rotor blades, servos, motors), while JPL is designing and integrating the other subsystems. The JPL thermal system team has designed the thermal control system of the Mars Helicopter to minimize the survival heater energy demand and meet the allowable flight temperature requirement of every component. The design choices have been made combining thermal analysis and testing at JPL. Because of the small size, the low power modes, and the nature of the technology demonstration approach, the Mars Helicopter presents both the challenges of an autonomous spacecraft and a cryogenic system. For this reason, there are higher levels of uncertainties related to the thermal design

and the Mars environment that have to be considered during the design phase. NASA JPL has used the Veritrek software products, in the form of the Veritrek Creation Tool and Veritrek Exploration tool, to be able to better study these uncertainties and understand the limits of the thermal design. Making use of the Veritrek software allowed for more effective exploration of the Mars Helicopter thermal design in a shorter period of time.

The Veritrek software (Figure 1) is an engineering analysis suite developed to improve upon and enhance the traditional thermal analysis process, by enabling thousands of simulation results in seconds. Built for Thermal Desktop®, Veritrek leverages the power of ROMs, which act as statistical emulators constructed from high-resolution simulations. Since 2009, a robust method for creating accurate ROMs has been developed and tested for a wide-range of applications, and has led to the development of the Veritrek Creation Tool. The Veritrek Creation Tool allows a user to create a ROM from a Thermal Desktop® model. A user can then import the ROM into the Veritrek Exploration Tool, which uses the ROM to perform rapid thermal analysis in the form of 2-D and 3-D plotting, sensitivity studies, screening analyses, and optimization studies.

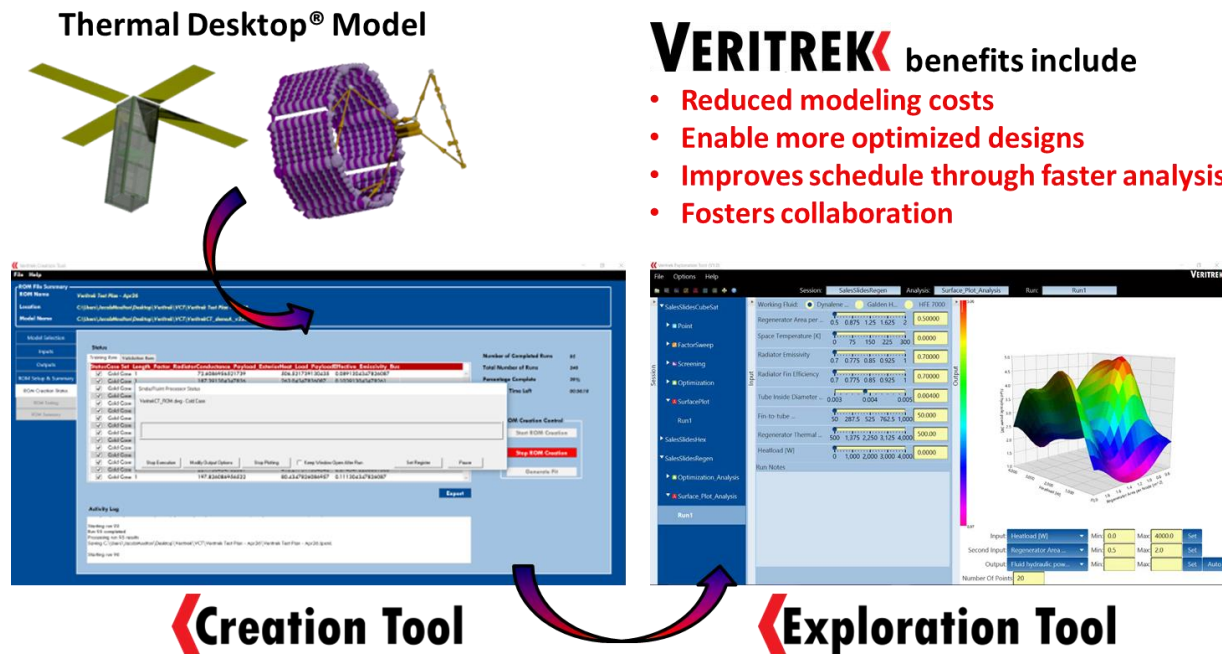

Figure 1. Veritrek software suite. Starting with a Thermal Desktop® model, a user can create a ROM using the Veritrek Creation Tool. Then, the ROM can be used in the Veritrek Exploration Tool to perform rapid thermal analysis using one of five available analysis features.

MARS HELICOPTER

The helicopter concept (Figure 2) will arrive at Mars as a deployable payload from the Mars 2020 rover. Once deployed and operating nominally, the helicopter will fly several times for up to 90 seconds per flight. Two cameras are planned to capture visible light images from the forward and nadir sides of the fuselage. Current and planned Mars surface missions can use

these reconnaissance images to aid terrain navigation or selection of sampling sites. Additionally, the helicopter can traverse and study terrain that would be inaccessible to rover or lander missions.

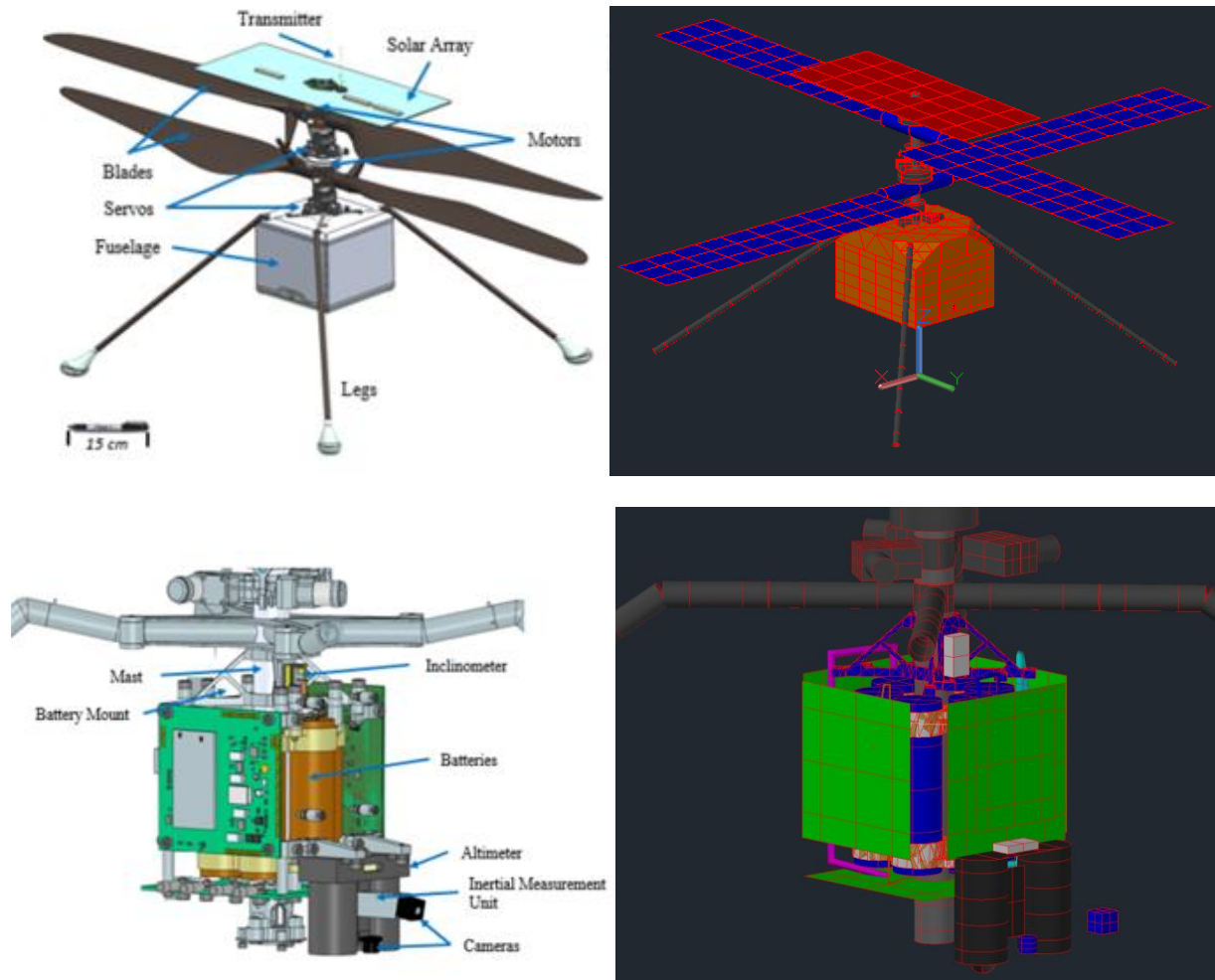

Figure 2. Model images of the helicopter concept. The left images show CAD rendering. The right images show the Thermal Desktop® model of the Helicopter [1]

Because of the low-density atmosphere of Mars, the Helicopter is very mass-limited (the system weighs around 1.8 kg). The Helicopter is powered by a 0.14 m² solar panel and six small lithium-ion batteries. The solar panel is capable of producing up to 42 Wh while the batteries can store up to 35 Wh. With such a limited power budget in an extreme environment, the optimization of the thermal design becomes critical for the success of the mission. The thermal subsystem utilizes almost 50% of the total energy available to the helicopter.

The Mars Helicopter thermal subsystem includes five different heaters zone that allow the system to stay within allowable flight temperature (AFT) during every phase of the mission. The battery heaters are always cycling to maintain the batteries at the desired temperature, during

charge, discharge and high rate discharge (flight). The amount of charge that the batteries can accept from the solar panel highly depends on the temperature of the batteries themselves. The interaction between the power and the thermal system for this particular component is critical and needs to be optimized. Other heaters zones include the rotor system heaters that warm up the servos and the prop motors electronics right before flight. Similarly, the upper sensor package, which includes a small IMU, and the lower sensor package, which includes the cameras and an altimeter have their respective heaters that allow the system to warm up the components and guarantee optimal performance during flight. The helicopter utilizes special coating material on the fuselage to minimize thermal losses due to radiation and absorb as much solar energy as possible to reduce the duty cycle of the heaters. The fuselage absorptivity was designed to have a value of 0.68. This also allows for the avoidance of reduced performance because of dust deposition. The emissivity of the fuselage was designed to have a value of 0.08. The α/ϵ ratio of 8.5 permits the system to minimize the survival energy of the batteries and avoid overheating of internal components during flight. Additional low emissivity tape is applied to the batteries and the internal part of the mast while blankets are placed between the ECM and the fuselage to reduce the radiation losses from the electronics. The JPL thermal team has evaluated the possibility of using aerogel to better insulate the internal components from the cold environment and minimize conduction losses. However, despite the increased performance of the thermal system, the savings in term of survival energy were not enough to justify the additional mass of the aerogel. Instead, the geometries inside the fuselage and the gas gaps between the components have been sized to optimize the design and reduce conduction heat losses through the gas. The Mars atmosphere is primarily composed of CO₂, which has a low thermal conductivity that varies between 0.008 W/mK to 0.0175 W/mK depending on the temperature. Because of the small gaps between the various components of the helicopter, there is no convection heat transfer within the fuselage on Mars. Other components that were utilized to increase the thermal system performance include ULTEM spacers and washers to reduce conduction heat transfer between the solid structures of the Helicopter.

The size of the system and the low power modes introduce thermal modeling challenges and uncertainties that are typical of cryogenic systems. In addition to that, the helicopter has to be completely autonomous and independent from the rover. The purpose of this study is to evaluate the uncertainties related to the Mars environment and other modeling assumptions to assess the thermal design robustness. In the following section, the selection of the six biggest thermal drivers that influence the performance of the Helicopter is shown, along with how these were evaluated with the Veritrek software.

REDUCED-ORDER MODEL DEVELOPMENT

ROMs are developed within the Veritrek Creation Tool using a statistical scheme based on sampling and data fitting an underlying Thermal Desktop® model. This approach is considerably different from nodal reduction methods in that it relies on a set of high-fidelity simulations (i.e.

training data) to generate the ROM. In doing this, the proposed approach is robust and can be easily applied to other problem classes, model types, and software packages.

The first step in developing a ROM is carefully selecting sampling points. Although full-factorial approaches examine all combinations of variables, they only do so at extreme values (i.e. design space boundaries). Consequently, interior points are overlooked, and ROMs can often fail far from the boundaries. Therefore, the Veritrek Creation Tool utilizes Latin Hypercube Sampling (LHS) space-filling designs to efficiently identify and evaluate interior points that would provide improvements in the reduced-order model. An LHS algorithm was developed based on concepts of the Maximin Method [2].

The Veritrek Creation Tool achieves data fitting using Gaussian Process (GP) regression methods. Introduced for computer experiments by Sacks, Welch, Mitchell, and Wynn [3], this approach is desirable in computer experiments since it provides an exact fit to the training data and requires only $k+1$ parameters, where k is the number of input factors. GPs do not impose a specific model structure on the underlying function being modeled. Instead, a Gaussian prior is placed on the range of possible functions that could represent the mapping of input factors to output responses. The Gaussian prior incorporates knowledge into the data about the underlying function and is specified using the GP covariance function, which provides a relationship between training data points. Although several approaches can be utilized for this correlation structure, the approach used the squared exponential (SE) covariance function, one of the most common. As such, GP modeling is a non-parametric modeling technique, where the training data are used to discover the model properties in a supervised manner. Details of the implemented GP method can be found from prior work [2].

The Mars Helicopter ROM was built to show the thermal design sensitivities of the Mars Helicopter concept, and to display the benefits of using the Veritrek software to evaluate thermal designs. The underlying Thermal Desktop® model consists of multiple cases that include the entire mission scenario, as well as symbols that change different aspects of the thermal design and environmental factors that influence the thermal performance of the Mars Helicopter. Six symbols were chosen as input factors for the ROM, along with two case sets, and 36 output responses. The input factors for the Mars Helicopter ROM consisted of Thermal Desktop® symbols that were set up as scaling factor multipliers used to control conductance, heat loads, heat transfer coefficient, and heater set point temperatures of the thermal model. The case sets included in the ROM consisted of a flight (hot case) and non-flight (cold case) environment for the Mars Helicopter. The 36 output responses consisted of maximum and minimum temperatures of different submodels within the Thermal Desktop® model, along with maximum and minimum heater energies for some of the different components. These ROM parameters are outlined and described in Table 1 through

Table 3.

Table 1. Summary of symbols used as Input Factors for the Mars Helicopter ROM

Symbol Name	Description
Gas Gaps Multiplier	Changes the insulation gas gaps within the fuselage
Rotor Sensor and Battery Cables Conduction Multiplier	Changes the overall conductance of the wires running from the batteries and the ECM to the sensors and to the rotor assembly components
Solids Conduction Multiplier	Changes the conductance of fasteners and other paths within the fuselage
Heatloads Multiplier	Changes the power dissipated by the electronics during operation
Battery Set Point Multiplier	Changes the batteries' heater set point during night survival
Convection	Changes the heat transfer coefficient of fuselage and other external components

Table 2. Summary of Case Sets used in the Mars Helicopter ROM

Case Set Name	Description
Jezero60_Tau2_NON_Flight	Jezero Ls 60, tau 0.2, non-flight sol, 1 comm COLD CASE
Jezero30_Tau7_Flight	Jezero Ls 30, tau 0.7, flight 11 am, 2 comm HOT CASE

Table 3. Summary of Output Responses used in the Mars Helicopter ROM

Output Response Name	Single Node	Node Group	Max Value	Min Value
Batteries Heater Energy	X		X	X
Upper Sensor Package Energy	X		X	X
Servos Heater Energy	X		X	X
Prop Motors Heaters Energy	X		X	X
NAV Heater Energy	X		X	X
LSP Heater Energy	X		X	X
Battery Temperature		X	X	X
ECM Temperature		X	X	X
Upper Sensor Package Temperature		X	X	X
Lower Sensor Package Temperature		X	X	X
Prop Motors Temperature		X	X	X
Prop Motor Electronics Temperature		X	X	X
Servos Temperature		X	X	X
Servos Electronics Temperature		X	X	X
Mast Temperature		X	X	X
Blades Temperature		X	X	X
Legs Temperature		X	X	X
Solar Array Temperature		X	X	X

RESULTS AND DISCUSSION

Mars Helicopter ROM Results

Three iterations of the Mars Helicopter ROM were performed. Each of the three iterations consisted of an increase in the number of sampling runs used during the ROM creation process, in an effort to improve the performance and accuracy of the ROM. All other ROM settings were

kept consistent. A summary of the number of sampling runs included in each iteration, along with information on the time it took to complete each iteration of the ROM are shown in Table 4. Ultimately, the ROM that was created using 452 sampling runs proved to be the most accurate and best-performing ROM for the Mars Helicopter and was therefore used to perform the rapid thermal analysis described later. It is important to note that the time taken to create the ROM is continuous and automated, requiring very little user intervention. After the Mars Helicopter ROM was set up with the desired input factors and output responses, the time to generate training data, fit the training data, and test the ROM was continuous.

Table 4. Time taken to create the Mars Helicopter ROM

ROM Creation Iteration	# Sampling Runs	Time to Generate Training Data*	Time to Fit the Data	Time to Test the ROM	Total Time for ROM Creation
1	128	64 hours	45 min	6 hours	~ 3 days
2	192	96 hours	3 hours	6 hours	~ 4.5 days
3	452	226 hours	16 hours	6 hours	~ 10 days

* The system used to generate the ROM was a Windows 10 laptop running AutoCAD 2017 and Thermal Desktop® 6.0 Patch 11. The processor on this system was a 4-core Intel Core i-7 at 2.80 GHz.

ROM performance was analyzed for each of the three ROM iterations, in order to compare the results obtained from the ROM and results obtained from the underlying Thermal Desktop® model. For each of the two case sets, all six input factors were analyzed individually. Five discrete runs were performed using Thermal Desktop® for each instance, and full factor sweeps were performed in the Veritrek Exploration Tool using each of the three ROM iterations. A summary on the amount of time taken to generate the data to make this comparison is shown in Table 5. A comparison of these results is shown in Figure 3 and Figure 4.

Table 5. Time taken to obtain thermal analysis results

Model and Method	Number of discrete runs performed	Time to complete runs and obtain meaningful results
Underlying Mars Helicopter Thermal Desktop® model	60	~ 30 hours
Mars Helicopter ROM in the Veritrek Exploration Tool	1200	A few seconds

The results shown in Figure 3 and Figure 4 show an obvious increase in ROM accuracy and performance with an increased number of sampling runs, which is to be expected. This is the basis of the reduced-order modeling approach, with the trade-off being that an increased number of sampling runs requires more time needed for ROM creation.

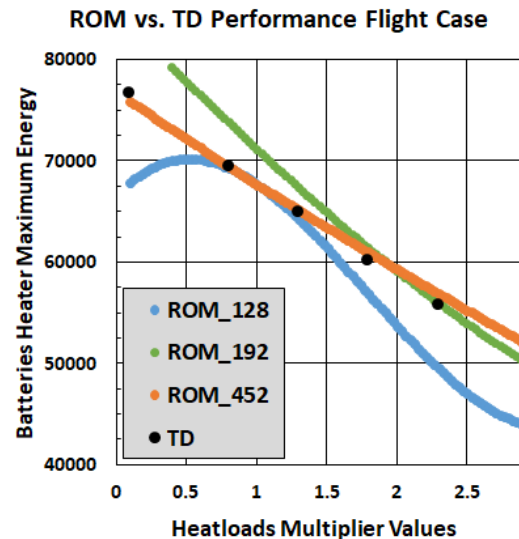
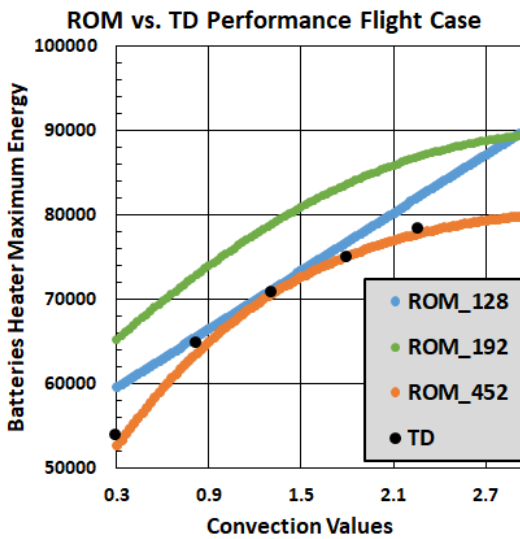
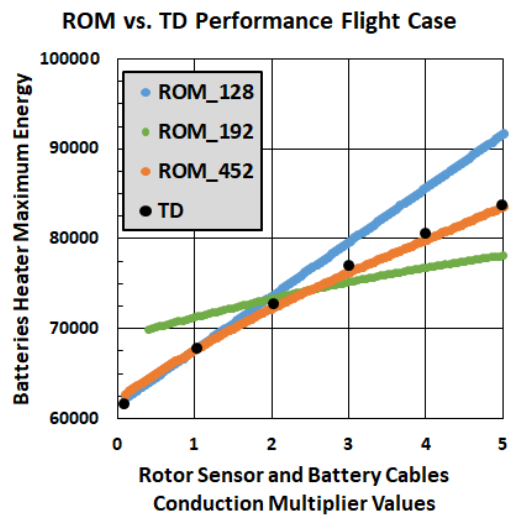
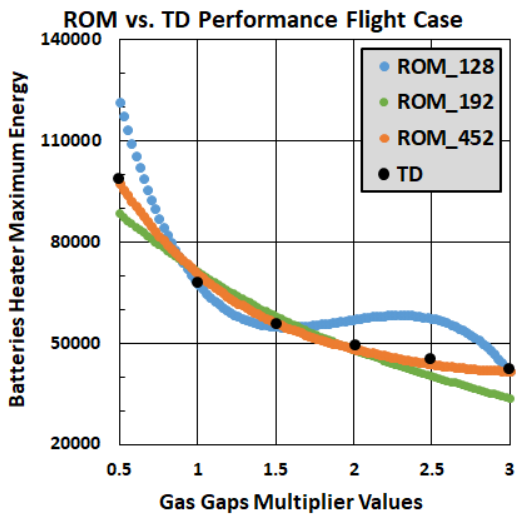
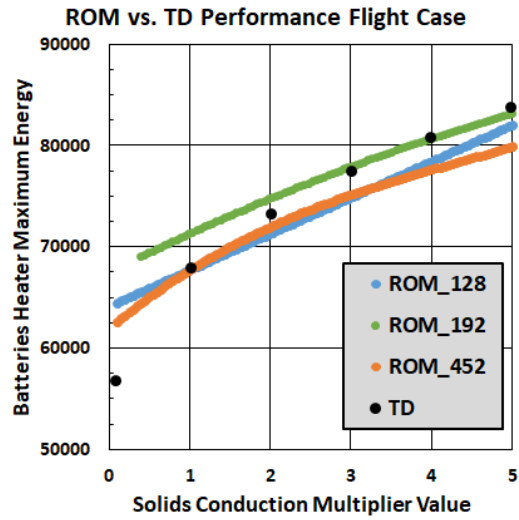
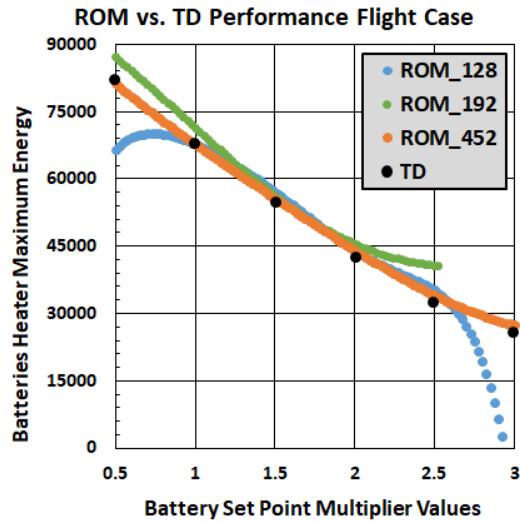

Figure 3. ROM vs. Thermal Desktop® Performance for the Flight case.

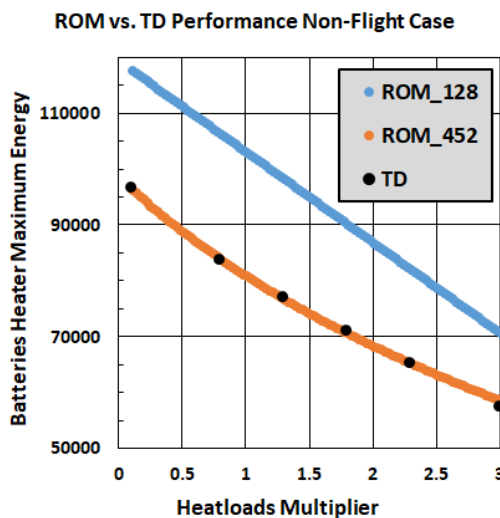
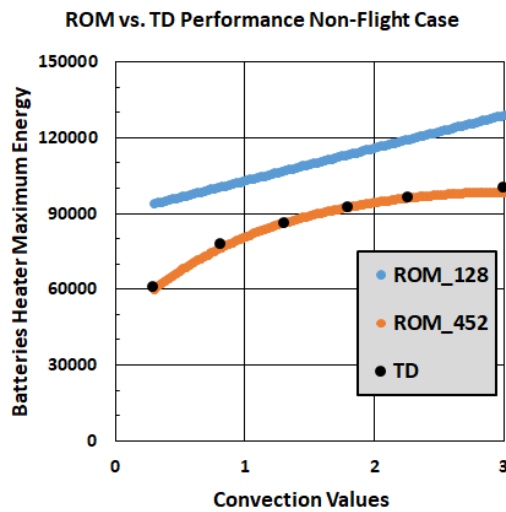
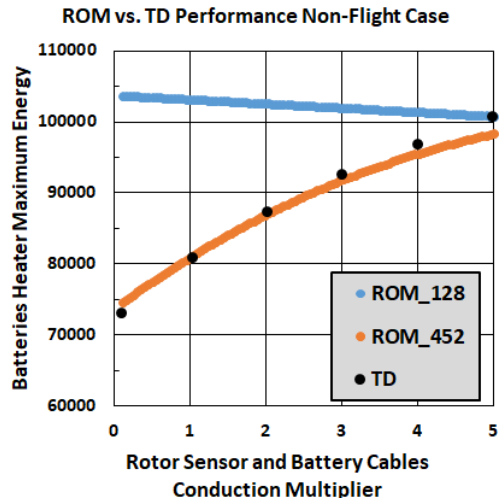
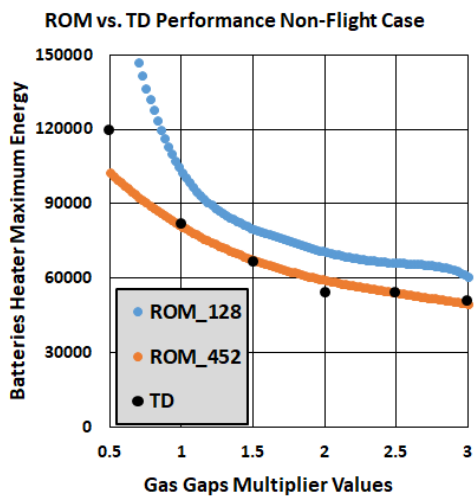
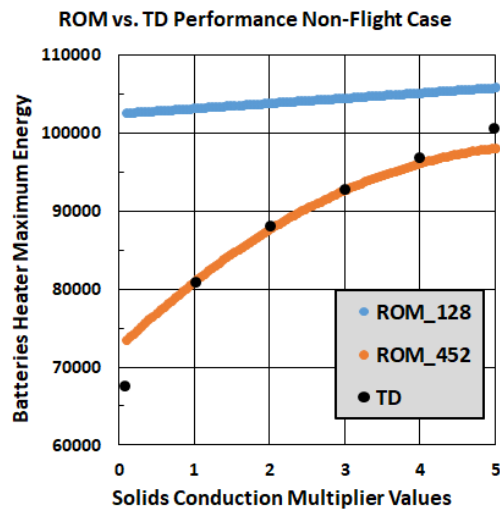
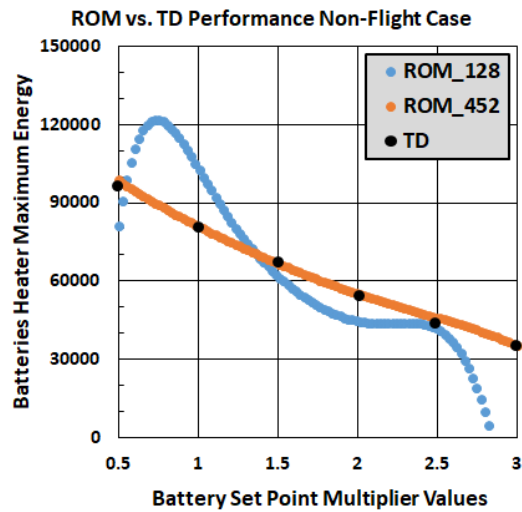

Figure 4. ROM vs. Thermal Desktop® Performance for the Non-Flight case.

Looking at Figure 3 and Figure 4, one could bring up the argument that generating the five discrete points in Thermal Desktop® and then trend fitting those five points may prove just as successful. However, it is important to point out this difference. The trends shown from the five discrete Thermal Desktop® points do not include results for any combination of input factors, whereas Veritrek immediately provides results for any combination of input factors within the defined design space and an infinite number of these trends and plots can be generated very quickly. This effectively provides thousands of simulation results in seconds, as opposed to the 30 hours taken to obtain only 60 simulation results using a traditional thermal analysis approach as seen in Table 5. After paying the upfront cost of 10 days to create the Mars Helicopter ROM, there is not any additional time needed to perform more runs or post-process the data, as the ROM and the Veritrek Exploration Tool provide these thermal analysis results in seconds. Also, the number of simulation results available using Veritrek is much greater than what would normally be achievable in the same amount of time using traditional thermal analysis methods.

There were 35 other output responses included in the Mars Helicopter ROM, which are not shown with the same level of detail as the Batteries Heater Maximum Energy output but are still of interest. The accuracy of the other output responses was evaluated using performance results obtained from directly within the Veritrek Creation Tool. The Veritrek Creation Tool provides its own ROM Testing, which compares how the created ROM performs relative to the underlying Thermal Desktop® model. Therefore, a user does not need to go thru the additional testing and validation efforts performed here, which were conducted merely as justification for the validity and utility of the software.

The Veritrek Creation Tool measures ROM performance by way of the mean of the residual and standard deviation of the residual, which is calculated from the difference between actual output results from Thermal Desktop® and results produced by the created ROM for a given number of random test points. For the Mars Helicopter ROM, there were 20 random test points generated by the Veritrek Creation Tool and used to compare ROM results to Thermal Desktop® results. A summary for the performance of all 36 output responses for the 20 random test points, provided by the Veritrek Creation Tool, is shown in Table 6.

Table 6. Mean and Standard Deviation of the Residual between ROM results and Thermal Desktop® results as provided by the Veritrek Creation Tool

Output Response Name	Mean of the Residual	Standard Deviation of the Residual
Battery Minimum Temperature	-0.875 °C	3.180 °C
Battery Maximum Temperature	-1.158 °C	5.350 °C
ECM Minimum Temperature	0.134 °C	1.148 °C
ECM Maximum Temperature	2.711 °C	19.375 °C
Legs Minimum Temperature	-0.048 °C	6.571 °C
Legs Maximum Temperature	5.525 °C	12.562 °C
Lower Sensor Package Minimum Temperature	-0.167 °C	1.096 °C
Lower Sensor Package Maximum Temperature	-2.407 °C	11.308 °C
Mast Minimum Temperature	0.002 °C	0.106 °C
Mast Maximum Temperature	1.024 °C	10.690 °C
Prop Motors Minimum Temperature	-0.004 °C	0.192 °C
Prop Motors Maximum Temperature	-0.091 °C	0.779 °C
Prop Motors Esc Minimum Temperature	0.015 °C	0.159 °C
Prop Motors Esc Maximum Temperature	-0.418 °C	3.131 °C
Rotor Minimum Temperature	-0.007 °C	0.006 °C
Rotor Maximum Temperature	-0.098 °C	1.392 °C
Servos Minimum Temperature	-0.164 °C	0.561 °C
Servos Maximum Temperature	1.642 °C	5.913 °C
Servos PCB Minimum Temperature	-0.164 °C	0.681 °C
Servos PCB Maximum Temperature	0.217 °C	1.712 °C
Solar Array Minimum Temperature	-0.079 °C	0.167 °C
Solar Array Maximum Temperature	0.329 °C	1.318 °C
Upper Sensor Package Minimum Temperature	-0.761 °C	1.939 °C
Upper Sensor Package Maximum Temperature	0.260 °C	4.616 °C
Batteries Heater Energy Minimum	0.000	0.000
Batteries Heater Energy Maximum	-1084.534	5652.170
USP, Servos, Prop Motors, NAV, LSP Heater Energy Minimum	0.000	0.000
USP, Servos, Prop Motors, NAV, LSP Heater Energy Maximum	0.000	0.000

Table 6 results show ROM performance for the 36 output responses. For 30 out of the 36 output responses, the ROM is performing well within 1°C of the underlying Thermal Desktop® model in terms of the mean of the residual. For 35 out of the 36 output responses, the ROM is performing within 3°C of the underlying Thermal Desktop® model for the mean of the residual. In addition, 29 out of the 36 output responses performed within 5°C in terms of the standard deviation of the residual. There were a few output responses that did not meet these residual thresholds relative to the underlying Thermal Desktop® model, and are currently being investigated; however, in general the ROM performed very well for this effort and for its desired use. These numerical residual results delivered by the Veritrek Creation Tool, along with the results shown in Figure 3 and Figure 4, provided enough verification and validation in the

ROM that NASA JPL engineers were confident to proceed with use of the ROM and the Veritrek Exploration Tool to perform the necessary thermal analyses and thermal design sensitivity studies of the Mars Helicopter.

MARS HELICOPTER THERMAL DESIGN RESULTS USING THE VERITREK EXPLORATION TOOL

Utilizing the Veritrek Exploration Tool, it was possible to quantify the effect of uncertainties related to the six selected input factors and verify the robustness of the thermal design. An optimization analysis was performed to verify that the final design’s parameters, even with uncertainties, would give output responses within the required design envelope. The Veritrek Exploration Tool randomly selects input factor values that are within the user-specified range and produces a single output response data point. Then, several thousands of these points can be generated very quickly within the Veritrek Exploration Tool to create a Pareto front plot that shows the design envelope for the designated output responses. To consider uncertainties of the six inputs on the flight (hot case) and non-flight (cold case) environments, the input factor ranges in Table 7 and Table 8 were considered respectively.

Table 7. Range of input factors for uncertainty quantification (Hot Case)

Hot Case - Jezero 30 Flight	Low Value	High Value
Convection - wind speed [m/s]	0	2.5
Heat loads	nominal	50% more (30% for high power modes during flight)
Gas Gaps	50% less	50% more
Cables Conductivity	80% less	100% more
Fasteners/Bonding Conductivity	80% less	100% more
Battery Set Point	-22	-15

Table 8. Range of input factors for uncertainty quantification (Cold Case)

Cold Case - Jezero 60 NON Flight	Low Value	High Value
Convection - wind speed [m/s]	5	7.5
Heat loads	50% less	nominal
Gas Gaps	50% less	50% more
Cables Conductivity	80% less	100% more
Fasteners/Bonding Conductivity	80% less	100% more
Battery Set Point	-22	-15

The following results shown in Figure 5, Figure 6, and Figure 7 provided by the Veritrek Exploration Tool show the response of the most critical Helicopter components: Batteries, ECM, Sensors, Servos and Prop Motors.

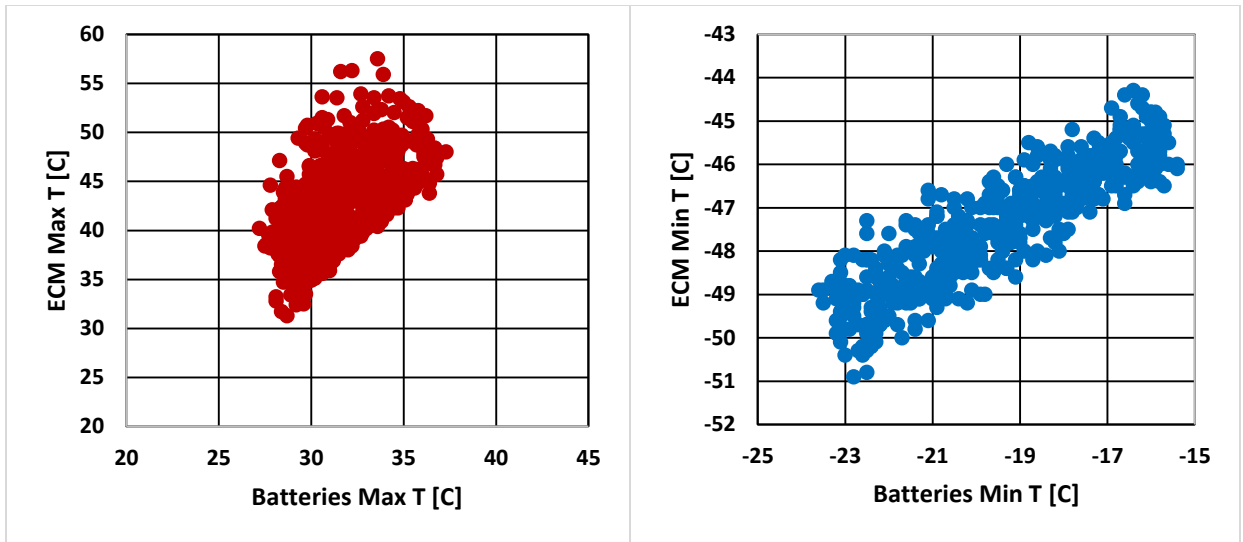

Figure 5. Batteries and ECM uncertainties predictions

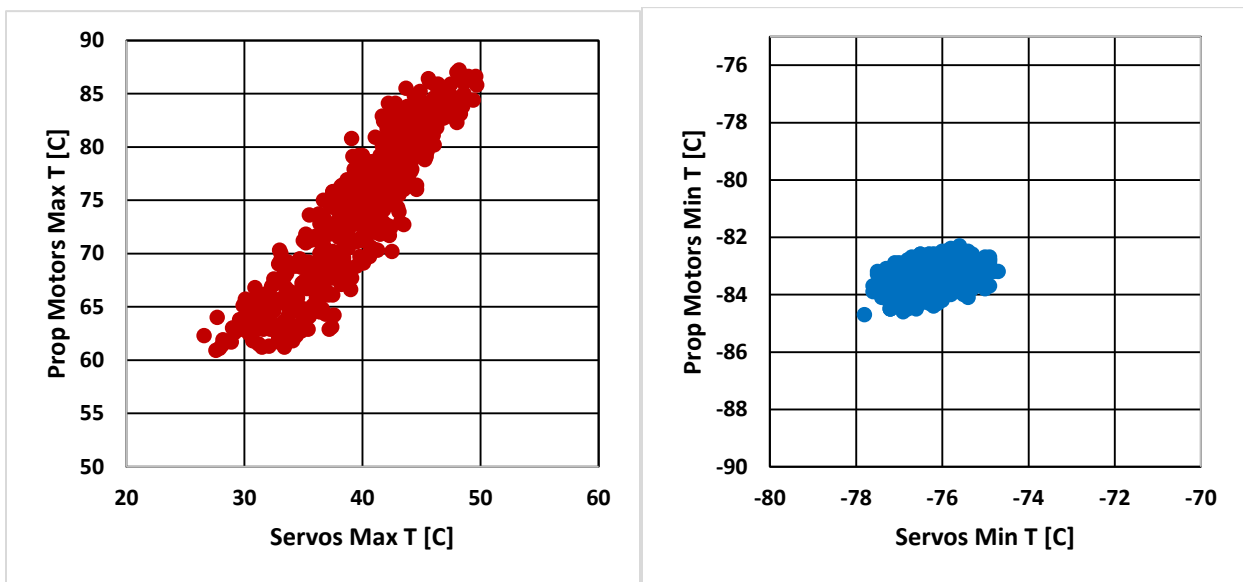

Figure 6. Servos and prop motors uncertainties predictions

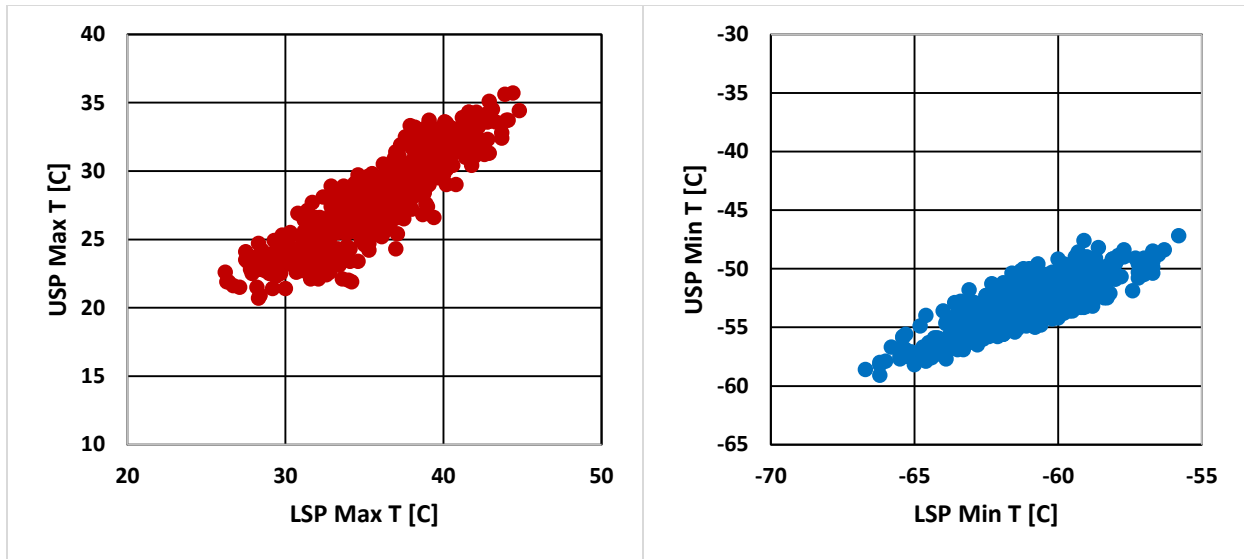

Figure 7. Lower Sensor Package and Upper Sensor Package uncertainties predictions

The previous graphs show the output responses of the Helicopter critical components. If the hot case is considered, it can be seen that the ECM and the Prop Motors exceeds the allowable flight temperature of about 5 °C for the worst combinations of the inputs parameters. Given the low probability of the worst conditions for every input parameter to be verified at the same time, these results give confidence in the Helicopter thermal design. Servos and the sensors (altimeter, IMU, cameras) do not exceed AFT even after introducing uncertainties.

If the cold case is considered, the thermal team was interested in knowing the effects on the system's components when the battery set point is lowered. Although this type of solution is not preferred since it pushes the lower temperature limit of the batteries, decreasing the heater set point allows saving a considerably high amount of survival energy. This type of solution could be applied at any time during the mission and this would allow flexibility to withstand extremely harsh and unpredicted conditions. The prop motors, the servos and the sensors stay within AFT with cold case uncertainties and with a lower battery heater set point. The ECM exceeds AFT of about 5 °C. The probability of this temperature to be exceeded is high if all the uncertainties are considered. JPL will take action to reevaluate the electronics performance at low temperature and update the AFT.

The level of uncertainties of the survival energy gets close to 27%. Lowering the batteries set point during operation would allow compensating for excessive unpredicted heat losses. These results can be seen in Figure 8.

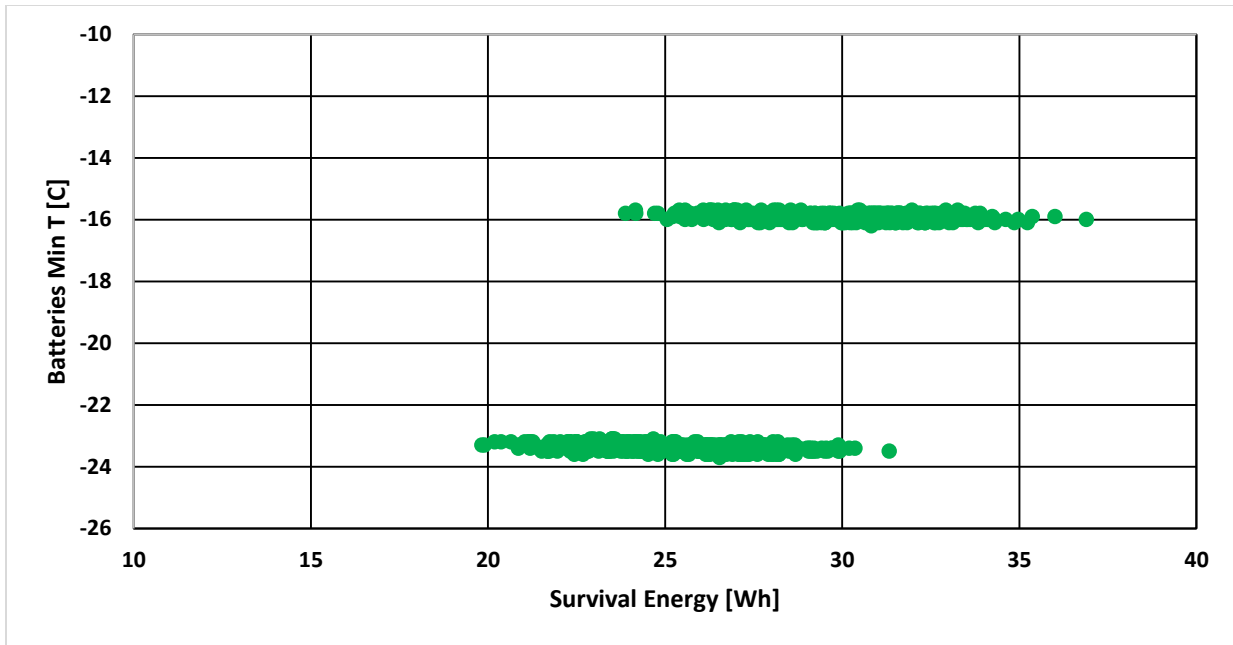

Figure 8. Survival Energy uncertainties predictions

A second investigation to assess the influence of the six input parameters on the survival energy has been completed with a screening analysis inside of the Veritrek Exploration Tool, as shown in Figure 9. This allowed the identification of the bigger drivers of the thermal design and provided insight on the requirements of critical components for the fabrication process. It also helped assessing the risk tied to uncertainties in the Mars environment predictions.

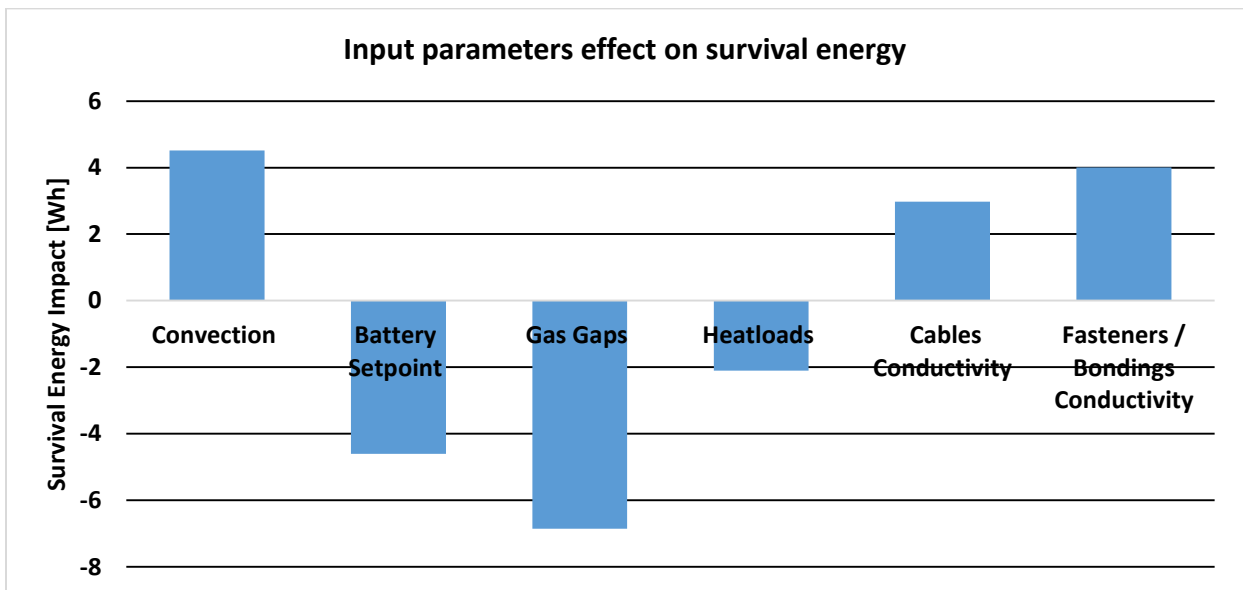

Figure 9. Input parameter effect on survival energy

FUTURE WORK

The results presented in this paper will be utilized to help formulate requirements for the fabrication and integration of the thermal system components. JPL plans to use the Veritrek software suite for future work that will investigate uncertainties in coatings optical properties, in order to study the thermal design sensitivities even further. Additional applications of the software might include thermal model correlation after thermal vacuum test of the Mars Helicopter flight model.

Based on the results of this effort, both the Veritrek Creation Tool and the Veritrek Exploration Tool have been shown to provide the necessary features and capabilities to be able to create a ROM from a high-fidelity Thermal Desktop® model and use that ROM to perform rapid thermal analysis. However, there are still several areas of enhancement that are planned for the future development of the software. This future development will be focused on the feedback and input from Veritrek users, in order to satisfy customer needs and desires. Future work for Veritrek includes enhanced sampling and data-fitting routines, along with providing several different options of these schemes and allowing the user to choose the sampling or data-fitting algorithm that best suits their ROM needs. Additionally, user feature and software enhancement requests are currently being addressed for future software releases. These include: the addition of more output responses available to users within the Creation Tool (i.e. Incident Heat, register values, capacitance, conductors, and fluid results), the ability to perform a Thermal Desktop® run from directly within the Veritrek Exploration Tool after observing ROM results, and the ability to perform the ROM creation runs in parallel using multiple instance of Thermal Desktop® in order to speed up the ROM creation process. The Veritrek software development plan is poised to meet the needs of a growing user base and mature both software tools into a robust engineering analysis suite.

CONCLUSIONS

In conclusion, the Veritrek software proved very valuable in allowing for the assessment of the Mars Helicopter thermal design sensitivities and verification of the final thermal design. The Mars Helicopter ROM was created and tested to prove its validity and accuracy relative to the underlying high-fidelity Thermal Desktop® model. After observing the Mars Helicopter ROM's performance, NASA JPL engineers were confident in the ability of the ROM to accurately and effectively perform the assessment of the Mars Helicopter's thermal design sensitivities.

The two specific areas of study for this effort, thermal design sensitivity of the Mars Helicopter and final assessment and verification of the thermal design, were both made easier and more effective with use of the Veritrek software. Specifically, the results provided by the Screening Analysis of the Veritrek Exploration Tool showed the effects of uncertainties for the six main thermal design drivers and gave insight on the sensitivity of the Mars Helicopter thermal design. Using traditional thermal analysis techniques to achieve these same thermal design sensitivity and uncertainty results would have been highly infeasible and nearly impossible due

to the amount of time and resources it would require. It would have taken over 75 days just to perform the necessary amount of runs, with the big assumptions that: all the runs were preprogrammed and set to automatically transition from one run to the next in a continuous fashion, a machine could be made available for this amount of time consistently, and the machine had enough memory to save all the results for the several thousand high-fidelity runs. This does not even include the necessary time that would need to be dedicated to post-process all of the results to obtain meaningful data. It is estimated that it would have taken over 4 months to obtain the same level of information that Veritrek provided to a single user in 10 days. These thermal design sensitivity results provided JPL with a better understanding of the critical components of the Mars Helicopter system and potentially allow JPL to utilize these results to optimize mission operation routines.

Additionally, the results provided by the Optimization Analysis of the Veritrek Exploration provided final assessment and verification of the already-determined Mars Helicopter thermal design. The Optimization Analysis provided a quick way to check the best and worst case thermal design scenarios for all component temperatures, to make sure that the components all stayed within an acceptable range of their design envelope. Although in this instance the Veritrek software did not provide any time-savings, as discrete best and worst case runs could have been performed with a traditional thermal analysis approach in the same amount of time, the Veritrek results did contain a lot more data than just the discrete best and worst case results. The Optimization Analysis results show the full design space envelope, not just the bounding case scenarios.

ACKNOWLEDGEMENTS

This research was carried out at the Jet Propulsion Laboratory, California Institute of Technology, under a contract with the National Aeronautics and Space Administration. The authors would like to thank Michael Pauken, Tyler Schmidt, Jennifer Miller and Mark Wagner for the contribution and support to the Mars Helicopter Project.

© 2018 California Institute of Technology. Government sponsorship acknowledged.

CONTACT

Stefano Cappucci | Thermal Fluid System Engineer | Jet Propulsion Laboratory | 4800 Oak Grove Dr Pasadena, CA 91109 | stefano.cappucci@jpl.nasa.gov | 818 354 3342

Jacob Moulton | Staff Engineer | LoadPath, LLC | 3333 South Bannock St., Ste. 430 | Englewood, CO 80110 | jmoulton@loadpath.com | 505.401.4853 | www.loadpath.com

Derek Hengeveld, PhD, PE | Senior Engineer | LoadPath, LLC | 2309 Renard Place SE, Ste. 101 | Albuquerque, NM 87106 | dhengeveld@loadpath.com | 605.690.1612 | www.loadpath.com

NOMENCLATURE, ACRONYMS, ABBREVIATIONS

α	absorptivity
ϵ	emissivity
k	number of input factors
AV	AeroVironment
AFT	Allowable Flight Temperatures
CO ₂	Carbon Dioxide
ECM	Electronic Core Module
GP	Gaussian Process
IMU	Inertial Measurement Unit
JPL	Jet Propulsion Laboratory
LHS	Latin Hypercube Sampling
ROM	Reduced-Order Model
SE	Squared Exponential
TRT	Temperatures Requirement Table

REFERENCES

- [1] S. C. , J. R. M. , M. F. W. , P. B. , a. Tyler M. Schmidt, "Thermal Design of a Mars Helicopter Technology Demonstration Concept," in *ICES 2018*, Albuquerque, 2018.
- [2] D. W. Hengeveld and A. Biskner, "Enhanced data exploration through Reduced-Order Models," in *47th International Conference on Environmental Systems*, Charleston, SC, 2017.
- [3] J. W. W. M. T. a. W. H. Sacks, "Design and analysis of computer experiments," *Statistical science*, pp. 409-423, 1989.