

Design and Transient Simulation of Vehicle Air Conditioning Systems

Brent A. Cullimore
C&R Technologies, Inc.

Terry J. Hendricks
National Renewable Energy Laboratory

ABSTRACT

This paper describes the need for dynamic (transient) simulation of automotive air conditioning systems, the reasons why such simulations are challenging, and the applicability of a general purpose off-the-shelf thermohydraulic analyzer to answer such challenges.

An overview of modeling methods for the basic components are presented, along with relevant approximations and their effect on speed and accuracy of the results.

THE MOTIVATION: THE NEED FOR DYNAMIC MODELING

Major Department of Energy (DoE) objectives include developing innovative transportation technologies and systems that decrease vehicle fuel consumption and emissions across the nation, thereby reducing the nation's reliance on foreign oil consumption. Recent changes to the Federal Test Procedure have added SC03 and US06 drive cycles to form the Supplemental Federal Test Procedure (STFP), with corresponding requirements for evaluating vehicle emissions during additional driving conditions. In particular, the SC03 drive cycle is specifically intended to evaluate vehicle emissions while the air conditioning (A/C) system is operating in typical high-temperature, high solar load conditions. The US06 drive cycle is intended to evaluate vehicle emissions during more high speed, high acceleration conditions.

The addition of the SC03 drive cycle creates a significant need for better understanding the impact of dynamic conditions (i.e., vehicle external environments, passenger compartment environments, etc.) on the vehicle A/C systems and their dynamic response to these conditions. Since vehicle A/C systems represent the major auxiliary load on the engine of light-duty passenger vehicles, sport-utility vehicles (SUV), and heavy-duty vehicles, the A/C system performance has a dramatic effect on fuel consumption

and exhaust emissions. Recent studies (Ref 1) have shown that, during the SC03 drive cycle, the average impact of the A/C system over a range of light-duty vehicles was to increase 1) fuel consumption by 28%, 2) carbon monoxide emissions by 71%, 3) nitrogen oxide emissions by 81%, and 4) non-methane hydrocarbons by 30%.

The A/C system experiences transient conditions throughout the SFTP drive cycles and during typical city/highway driving patterns around the country. In particular, the evaporator load, compressor speed, refrigerant flow rate, and heat exchanger airflow rates can be quite variable. Knowledge and better understanding of the transient A/C system behavior, especially the integrated interdependencies and strong coupling between system components, is critical to understanding A/C system performance requirements during these drive cycles. There must be increased emphasis on optimizing the integrated A/C system design and performance under these transient conditions, rather than simply focusing on peak steady-state conditions, to minimize its impact on vehicle fuel economy and emissions across the spectrum of the nation's vehicle fleet.

THE PROBLEM: TRANSIENT SELF-DETERMINATION OF PRESSURE

Rankine cycles are taught in every introductory undergraduate thermodynamic course, and the basic vapor compression cycle used in most A/C systems is essentially a reverse Rankine cycle. In such simple treatises, pressures are specified and no consideration is given to conserving working fluid mass. In a real application, of course, the A/C unit is charged with a fixed mass of refrigerant, and the high and low pressures will vary as will the coefficient of performance (COP) of the unit. The accurate prediction of these pressures turns out to be rather complicated.

Obviously, analytic models of compressors and throttling devices must predict pressure rises and drops accurately. But it may not be as obvious that comparatively isobaric

devices such as condensers, evaporators, and transport lines have an influence on the resulting pressure levels, *because, with the exception of the receiver/drier, it is in those components that the amount of working fluid charge varies the most.*

At any instantaneous operating point, the energy flows through the loop must balance (neglecting transient thermal and thermodynamic storage terms). This means that the heat transfer coefficients (and degree of single-phase "blockage") in the condensers and evaporators must be calculated accurately. This in turn means that the regimes and thermodynamic qualities within the condensers and evaporators must be calculated accurately, conserving total charge mass in the system.

To predict the upper and lower operating pressures at any steady operating point, or to track changes in those pressures during dynamic cycle operation, requires that the analytic model be able to track and conserve charge mass, and to determine its distribution. Because the resulting pressures in turn influence the operating conditions with the evaporator and condenser, *a surprisingly tightly coupled and detailed solution is required to correctly predict the performance, as depicted¹ in Figure 1.*

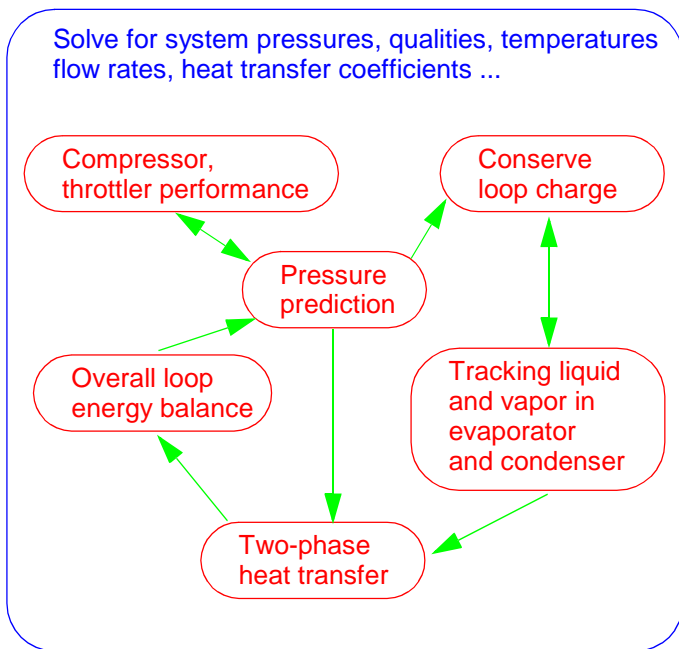

Figure 1. Tightly Coupled Analysis is Required

SINDA/FLUINT OVERVIEW

Understanding some of the modeling choices presented in this paper requires a brief overview of the nomenclature and concepts in the SINDA/FLUINT thermohydraulic analyzer (Ref 1).

1. This figure is not representative of any implemented solution procedure. Rather, it is intended only to illustrate the necessity for nontrivial solution techniques.

SINDA/FLUINT is used to design and simulate thermal/fluid systems that can be represented in networks corresponding to finite difference, finite element, and/or lumped parameter equations. In addition to conduction, convection, and radiation heat transfer, the program can model steady or unsteady single- and two-phase flow networks, including nonreacting mixtures and nonequilibrium phenomena.

Table 1 presents the overall organization of available modeling tools.

SINDA (Thermal Networks)—SINDA uses a thermal network approach, breaking a problem down into points at which energy is conserved (*nodes*), and into the paths (*conductors*) through which these points exchange energy via radiation and conduction. While often applied as a lumped-parameter modeling tool, the program can also be used to solve the finite difference (FDM) or finite element (FEM) equations for conduction in appropriately meshed shells or solids. One can employ finite difference, finite element, and arbitrary (lumped parameter) nodes all within the same model.

FLUINT (Fluid Networks)—FLUINT uses a different type of network composed of *lumps* and *paths*, which are analogous to thermal nodes and conductors, but which are much more suited to fluid system modeling. Unlike thermal networks, fluid networks are able to simultaneously conserve mass and momentum as well as energy.

Lumps are subdivided into *tanks* (finite-volume control volumes), *junctions* (zero-volume control volumes: conservation points, instantaneous control volumes), and *plena* (boundary states). Paths are subdivided into *tubes* (inertial ducts), or *connectors* (instantaneous flow passages including short [zero inertia] ducts, valves, etc.).

In addition to lumps and paths, there are three additional fluid network elements: *ties*, *fties*, and *ifaces*. Ties represent heat transfer between the fluid and the wall (i.e., between FLUINT and SINDA). Fties or "fluid ties" represent heat transfer within the fluid itself. Ifaces or "interface elements" represent moving boundaries between adjacent control volumes.

FLUINT models can be constructed that employ fully transient thermohydraulic solutions (using *tanks*), or that perform pseudo-steady transient solutions (neglecting perhaps inertial effects and other mass and energy storage terms using *junctions*), or that employ both techniques at once. In other words, the engineer has the ability to approximate or idealize where possible, and to focus computational resources where necessary. As will be described later, these choices are critical for successful modeling of vapor compression cycles.

Built-in Spreadsheet and User Logic—A built-in spreadsheet enables users to define custom (and perhaps interrelated) variables called *registers* (Figure 2). Users can also define complex self-resolving interrelationships between

Table 1: Hierarchy of Modeling Options

Thermal/Fluid Models

Registers, Expressions, and Spreadsheet Relationships

Concurrently Executed User Logic

Thermal Submodels

Nodes

Diffusion (finite capacitance)

Temperature-varying

Time-varying

Arithmetic (massless: instantaneous)

Boundary (constant temp.)

Heater (constant temp., returns power)

Conductors

Linear (conduction, advection)

Temperature-varying

Time-varying

Radiation

Temperature-varying

Time-varying

Sources

Temperature-varying

Time-varying

Fluid Submodels

Lumps

Tanks (finite volume)

Twinned tanks (nonequilibrium modeling)

Junctions (zero volume: instantaneous)

Plena (constant temperature, pressure)

Paths

Tubes (finite inertia)

twinned tubes (slip flow)

Connectors (zero inertia: instantaneous)

short tubes (STUBEs)

twinned STUBEs (slip flow)

valves

check valves, control valves

pressure regulating valves

K-factor losses, bidirectional or not

pumps, fixed or variable speed

constant mass or volumetric flow rate

capillary elements (CAPILs)

Ties (heat transfer)

user-input conductance

program-calculation (convection) conductance

Duct macros (subdivided pipelines)

Capillary evaporator-pumps (CAPPMP macros)

Ifaces (control volume interfaces), with or without inertia

flat (zero pressure difference)

offset (finite pressure difference)

spring (i.e., bellows, etc.)

spherical bubble

wick (liquid-vapor interface in porous structure)

Fties (fluid-to-fluid ties)

axial in a duct

user-input conductance

constant heat rate

Auxiliary Utilities

choked flow detection and modeling

waterhammer and acoustic wave modeling

compressors

Solutions

Steady-state

Transient

Goal Seeking

Design Optimization

Test Data Correlation

Reliability Estimation

Robust Design

Int	Name	Expression	Comment
<input type="checkbox"/>	disp	0.00017777	compressor volumetric displacement per revolt
<input type="checkbox"/>	DmanC	0.6*TcoreC / 0.6	manifold hydraulic diameter, condenser
<input type="checkbox"/>	DmanE	0.5*TcoreE	manifold hydraulic diameter, evaporator
<input type="checkbox"/>	dtactual	refr.dtimuf	for diagnostics
<input type="checkbox"/>	dtchar	10.0	expected time constant for time-dependent
<input type="checkbox"/>	DtubeC	1.72*0.9	refr side hydraulic dia, condenser, mm, 1.72 +/-
<input type="checkbox"/>	DtubeE	1.8*2.0	refr side hydraulic dia, evaporator, mm, 1.8 +/-
<input type="checkbox"/>	emcomp	etaVol*(disp*rpm/60)*refr.dl1000	mass flowrate in compressor
<input type="checkbox"/>	emlags	0.7	delay in adopting emcomp steady state
<input type="checkbox"/>	emlagt	0.95	emlag for transients
<input type="checkbox"/>	etalsen	1.0 - max(0,min(1,(cb0)/(prat*rpmf) + cb1/pra	isentropic efficiency
<input type="checkbox"/>	etaVol	1.0 - max(0,min(1,(ca0/rpmf + ca1 + ca2*pra	volumetric efficiency

Figure 2. Part of the Built-in Spreadsheet: User-defined Registers

inputs, and also between inputs and outputs. This spreadsheet allows rapid and consistent model changes, minimizes the need for user logic, and makes parametric and sensitivity studies easy to perform.

During program operation, concurrently executed logic blocks are also available, paralleling the spreadsheet system. In both the spreadsheet and the logic blocks, full access is provided not only to the basic modeling parameters (dimensions, properties, loss factors, etc.), but also to program control parameters and to underlying correlations for heat transfer, pressure drop, fluid properties, etc.

WORKING FLUID PROPERTIES

Because of the range of pressures involved and the presence of two-phase flow, vapor compression cycle analyses require a full-range set of properties with the vapor phase treated as a real (not perfect) gas. For R134a, several such sets of property data exist, but the one most commonly employed is a tabular description created from NIST's REFPROP database (Ref 3).

Properties for other fluids of interest to A/C systems are available including HFCs, HCFCs, supercritical carbon dioxide, and moist air (for passenger compartment or environmental psychrometric analyses). Also, noncondensable gases and nonvolatile liquids (e.g., oils) can be added to the mixture.

However, for the purposes of this paper, pure R134a is assumed unless otherwise noted.

VAPOR COMPRESSION CYCLE COMPONENTS

This section describes the main components within a typical vapor compression cycle. A building-block approach

allows both the arrangement of the components and the methods of modeling them to be variable.

COMPRESSOR

As with all devices, there are many ways to model a compressor depending on the information available and the detail desired.

While some organizations have developed models focusing on the internal operation of scroll and reciprocating compressors, most analyses treat the compressor as a “black box” given isentropic and volumetric efficiencies. These efficiencies normally vary as a function of the compressor speed, the suction pressure, and the discharge pressures. A “map” of such efficiencies as a function of these or other parameters can be supplied in the form of equations or tables.

Given such a compressor map, a simple approach, is to model the compressor as volumetric flow rate source, whose flow rate is calculated as a function of current volumetric efficiency:

$$G = D \cdot \omega \cdot \eta_v$$

where G is the volumetric flow rate (m^3/s), D is the compressor displacement (m^3), ω is the compressor speed (RPS, or $RPM \cdot 60$), and η_v is the volumetric efficiency.

The compressor outlet temperature is calculated as a function of current isentropic efficiency. This calculation is made exploiting the availability of user logic, combined with direct access to underlying working fluid properties such as vapor entropies.

With the above method, the compressor volumetric flow rate is held constant during each time step and during each steady-state relaxation step. A modest (approximately 25%) speed improvement can be gained by specifying not only the volumetric flow rate, but also the slope of the flow rate versus pressure gain curve ($\partial G / \partial \Delta P$, where ΔP is the pressure drop across the compressor). This parameter allows the implicit solution to adjust the flow rate during the time step or relaxation step. This derivative can be calculated either in closed form equations (if available) or by finite difference perturbations in user logic.

Note that the compressor speed can be regulated dynamically (i.e., during the steady or transient solution) as needed either to achieve some control purpose (perhaps as simple as on/off), or as needed to match a usage or load profile of compressor speed versus time.

CONDENSER AND EVAPORATOR

Condensers, evaporators, and in fact any fluid passage in which the temperature or pressure or quality can change are modeled using discretized (subdivided) chains of con-

trol volumes (“lumps”) and flow passages (“paths”), as shown in Figure 3.

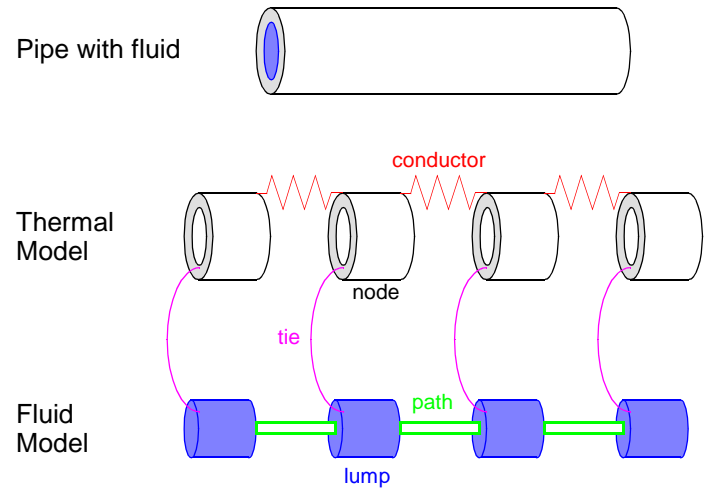

Figure 3. Discretization of a Line with Heat Transfer

These situations are commonplace, and therefore special duct macrocommands (“*duct macros*”) exist to facilitate such modeling. (Some duct macros are shown expanded in Figure 5.)

A general-purpose thermohydraulic analyzer must take a “presume nothing” approach that solves the general problem, invoking heat transfer and pressure drop and flow regime mapping algorithms but otherwise letting the flow in the component resolve itself along with the rest of the system. If the wall is cold, condensation occurs. If enough condensation takes place, the liquid may be subcooled at the exit. This distinction is present for steady state solutions, but becomes critical for transient solutions.

Liquid/Vapor Front Tracking—One benefit of taking a generalized approach is the ability to automatically track liquid and vapor within the evaporator, condenser, and elsewhere. At the exit of a condenser for example, very little heat transfer occurs in the subcooled region, which can essentially be considered “blockage,” affecting the overall energy balance of the loop.

Slip Flow—A simple approach is to treat two-phase flow as a homogeneous, well-mixed (phasic equilibrium) fluid: effectively, as an equivalent single-phase fluid. While this simplification is often adequate and therefore worth the additional computational efficiency, it is also possible to model slip flow. Slip flow allows vapor and liquid flows to travel at different velocities according to the local flow regime (which affects the degree of interphase friction, apportionment of wall friction to each phase, etc.). In other words, it is possible either to use a single flow rate and momentum equation (homogeneous approach), or to use one flow rate and one momentum equation *per phase*.¹

This distinction may seem elaborate, and indeed few thermohydraulic analyzers are able to make this distinction. However, slip flow modeling can be important for vapor compression cycle modeling since it improves the prediction of void fraction: the relative amounts of liquid and vapor within components such as evaporators and condensers. Improved correlation to test data was found using the slip flow options in dynamic A/C modeling, as reported in Reference 4.

Figure 4 illustrates the potential importance of slip flow graphically.¹

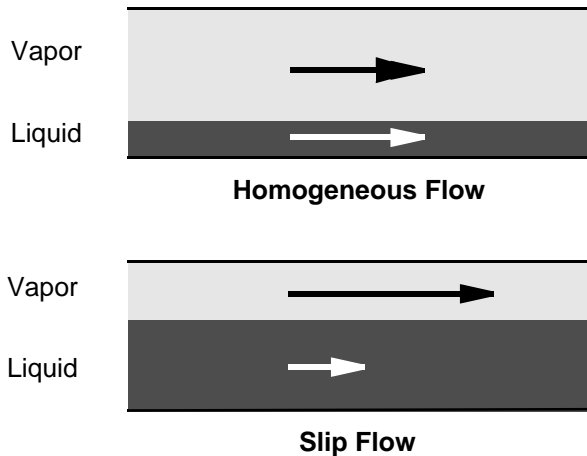

Figure 4. Effect of Homogenous vs. Slip Flow on Void Fraction Estimation and therefore Charge Mass Tracking

Custom Heat Exchangers—Evaporators and condensers are rarely simple tubes. At the very least, they are often parallel arrays of manifolded and perhaps internally finned passages.

While the complexities of manifolding can be modeled explicitly, such a level of detail is usually only required for predicting manifolding efficiencies, uneven distribution in the external (i.e., air) flows, or perhaps unsteady oscillations between parallel passages. For faster top-level modeling, the symmetry of the situation should be exploited by modeling one typical passage and then magnifying it according to the number of actual passages.

1. It is even possible to avoid the assumption of thermal nonequilibrium: to solve for liquid and vapor temperatures and pressures separately. However, the significant added cost of such an elaborate solution can almost always be avoided in automotive vapor compression cycle analyses.

1. The actual changes in void fraction predictions are often not as dramatic as Figure 4 would seem to indicate: that illustration is not based on an actual analysis.

Many of the readily available heat transfer and pressure drop correlations are for circular tubes, and even then most are honed for water instead of R134a. While it is possible to add additional correlations specific to each situation, alternatives exist for handling the uncertainties involved. These methods use the readily available best-estimate correlations as a basis to which scaling factors can be applied.

In preliminary design stages, the sensitivity to uncertainties in these correlations can be measured by a simple parametric sensitivity study. However, a more complete statistical design module (Ref 5) is available to determine the combined effects of several uncertainties at once.

When test data becomes available in later design phases, the uncertainties can be reduced by automated calibration of the model (Ref 6). In this mode, the “best fit” values of the scaling factors are determined as needed to adjust the best-estimate correlations.

Integration with Condenser Air Flow Models—The air side of the condenser can be modeled simply, or in detail. A separate fluid model can be used to describe the air flow across the condenser, perhaps interpolating velocities produced by a CFD code in the case of flow through an automobile radiator. In addition, heat exchange between the transport lines and the environment (perhaps the engine compartment) can be included.

Integration with Evaporator Air Flow Models—As with the condenser, the air side of the evaporator heat exchanger can be modeled simply, or in detail. This model can include moist air psychrometrics, including diffusion-limited condensation. The model can also be extended to include the dry or moist air environment associated with the passenger compartment. Figure 5 presents a diagram of a counterflow heat exchanger with an R134a evaporator on one side and moist air on the other.

THROTTLING DEVICES

Orifices and Valves—Orifices and valves are usually modeled as simple K-factor losses (fractions of dynamic head): $\Delta P = K \cdot \rho \cdot V^2 / 2$, where ρ is the fluid density and V is the basis velocity.

In addition, a check for choked flow is usually required. There are several two-phase choked flow calculation methods available, but good results are usually had by assuming a nonequilibrium expansion (i.e., the liquid does not have time to flash much within the restriction) plus a metastable (quasi-equilibrium) method for the prediction of the sonic velocity within the two-phase throat (Ref 7).

Temperature-control valves (TXV) can be modeled as a device with variable K (where the K factor is adjusted within expressions and/or user logic, perhaps using a PID controller). However, a simpler method is to model them as back pressure regulating valves, where the back pressure is cal-

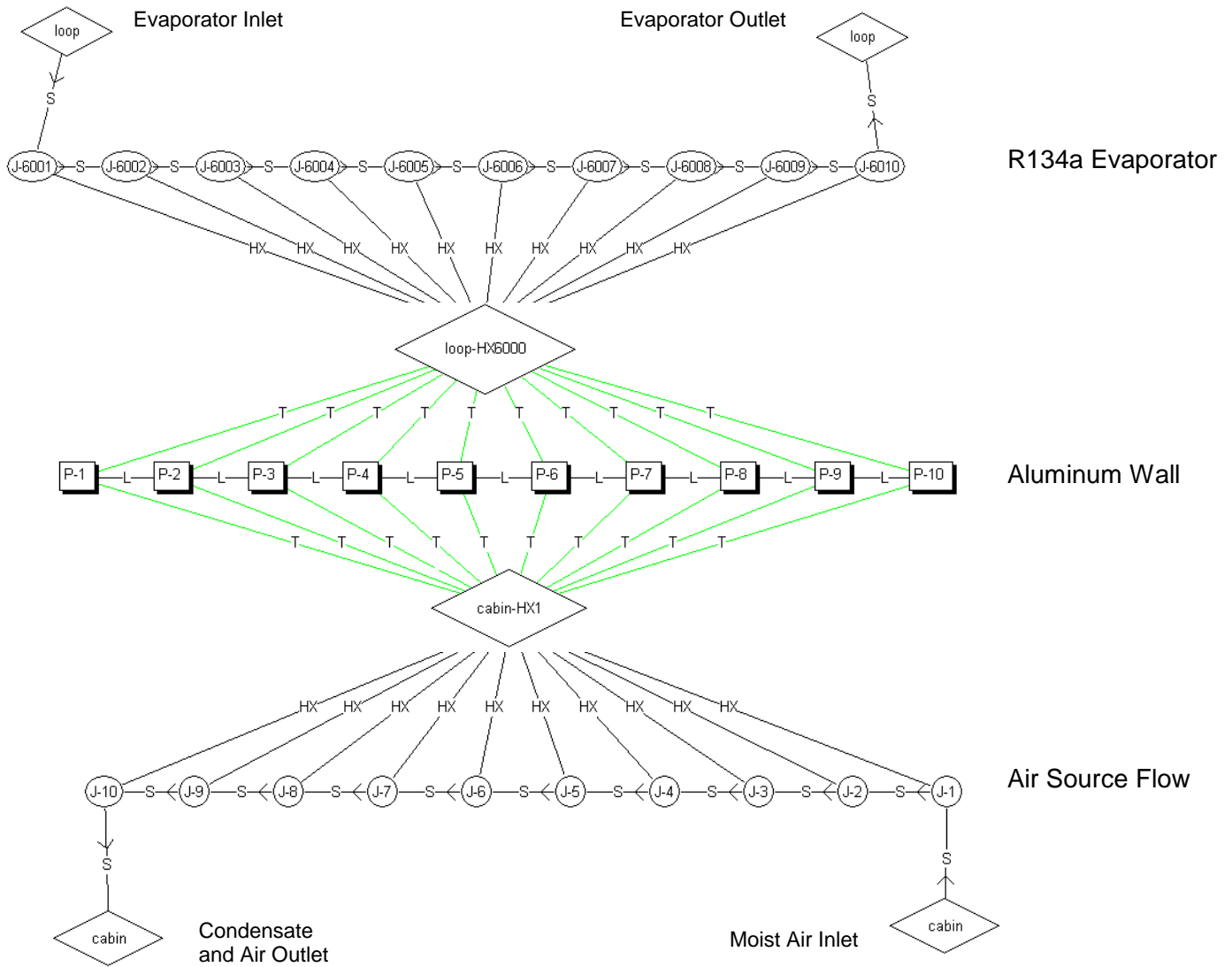

Figure 5. Moist Air Counter-flowing with R134a in One Possible Evaporator Model

culated as the appropriate saturation condition in the evaporator required to yield the desired compressor inlet superheat.

Capillary Tubes—Long thin tubes ($L/D \gg 50$) are modeled no differently from evaporators or condensers: duct macros (serial strings of control volumes and flow passages) may be applied. In fact, the only difference is that the fluid inertia in such lines is less negligible than in condensers and evaporators, while the amount of fluid within it is often negligible. In other words, due to the small diameters, it is quite reasonable to neglect the mass and energy storage terms within capillary tubes (dM/dt , dU/dt , where M is the control volume mass and U is the control volume internal energy) while *not* neglecting the inertial term $d(\rho \cdot G)/dt$.

When inertia is neglected in a flow passage, the flow rate responds to changes in conditions in a time-independent fashion: as an algebraic momentum equation. If instead inertia is included, a time-dependent (differential) momen-

tum equation is used such that a finite amount of time is required to accelerate or decelerate the fluid within that passage.

The heat transfer and thermal environment on these capillary tubes can be arbitrarily complex, including regenerative interconnections with other components such as suction lines. Such interconnections are not difficult nor expensive to include in a network-style approach.

Orifice Tubes—The performance of orifice tubes ($L/D < 20$) is not well modeled using first-principles approaches implicit in the standard SINDA/FLUINT building blocks. Therefore, these devices are modeled as “constant” flow rate devices, where the flow rate is adjusted dynamically according to a user-provided correlation (perhaps generated from test data).

TRACKING CHARGE: SELF-DETERMINATION OF PRESSURE

This topic, which was introduced earlier, will now be expanded to describe some of the various decisions that must be made in modeling vapor compression cycles.

Various trade-offs exist when modeling vapor compression cycles with known charge and unknown pressures. These trade-offs result from the fact that SINDA/FLUINT *tanks* (finite size control volumes) determine their own pressure based on conservation of mass and energy, while *junctions* (zero size control “volumes”) are faster executing approximations that rely on tanks or boundary conditions in the loop to ultimately determine their pressure. In other words, a model that faithfully employs *tanks* even for the smallest volume will automatically determine its own loop pressure but will run slowly, while a model built mostly of *junctions* will execute quickly, but will must be provided a reference pressure since total charge would not be tracked.

SOLUTION #1: USING ALL TANKS

The simplest solution to explain and to implement is to simply use finite-volume *tanks* to model most if not all of the loop. Small volumes such as capillary tubes, orifices, tees, etc. can still be modeled using zero-volume *junctions*, but otherwise tanks are used elsewhere (especially within the evaporators and condenser).

Such a model is slow to solve, however, requiring time steps that are on the order of 0.1 second (0.01 to 1 second). Unless the dynamics of the first few seconds of compressor start-up are of interest, then this choice is inappropriate for environmentally-dominated transients or parametric steady-state runs.

SOLUTION #2: USING SOME TANKS

Another method is to use fewer, larger tanks. For example, the condenser can be subdivided axially into halves or thirds, using junctions within each segment but connecting the segments with tanks representing the volume of the segment. In other words, the volume of the component is lumped into one or two tanks, but the two-phase gradients within the component are captured using junctions.

In one model, the condenser was modeled using tanks, but because the other components filled mostly with low pressure vapor (such as the evaporator and suction lines), they were modeled using faster executing junctions. Similarly, components with small volumes (such as the capillary tube) were modeled using junctions. Whenever junctions were used for speed, the volume of the component was applied to adjacent tanks so as to “conserve volume.” This model runs with approximately 1 second time steps, limited mostly by hydrodynamic events occurring in the condenser.

SOLUTION #3: USING ALL JUNCTIONS

A model using all junctions solves very quickly, but must have at least boundary condition present as a reference pressure. In other words, the pressure is prescribed, and the mass in the system is calculated rather than the desired reverse case. In such a model, the pressure of the reference point must then be adjusted to yield the correct charge. There are three suboptions available for performing this adjustment.

Parameterizing Charge—If the charge is unknown or variable, then the above model serves well for steady-state analyses. The pressure of the plenum can be varied parametrically, and the resulting performance plotted against either the pressure or the charge.

Using Goal Seeking—If only steady state analyses are required, then the goal seeking module (Ref 6) can be used to automatically find the plenum pressure that results in the desired charge.

Using Control Logic—If transient analyses are required, then the plenum pressure must be controlled such that the correct charge is present in the system. This control cannot be perfect. Rather, the goal of the control logic is to make sure the error in charge is acceptably small while not causing long run times. (After all, if long run times result, the analyst is better off switching to tanks and eliminating the error all together.)

Such control logic has been written and examples are available, but such logic is usually specific to each cycle. A more generalized solution is to use a PID controller.

EXAMPLE APPLICATION: NREL'S NOMINAL AIR CONDITIONING SYSTEM

In order to more completely understand transient A/C system performance and its impact on vehicle fuel consumption and emissions, a transient A/C model has been developed within the SINDA/FLUNT analysis software environment and integrated with NREL's ADVISOR vehicle systems analysis software.

The model was developed using a nominal representative A/C system that was identified in discussions with NREL's automotive industry partners. This transient model captures all the relevant physics of transient A/C system performance, including two-phase flow effects in the evaporator and condenser, system mass effects, air side heat transfer on the condenser/evaporator, vehicle speed effects, temperature-dependent properties, and integration with a simplified cabin thermal model. The intent of the model is to evaluate various vehicle and A/C system design options and identify the best design opportunities for increasing fuel economy and reducing emissions.

The transient A/C model is also integrated with a simplified cabin thermal model, thereby providing the system perfor-

mance link connecting cabin thermal comfort requirements back to vehicle fuel consumption and emissions. A/C system thermal-hydraulic conditions and cabin thermal conditions can be predicted during various drive cycles, including vehicle idle, SC03, US06 or other typical federal test and passenger-induced drive cycles. The SC03 and US06 federal drive cycles presented in Hendricks (Ref 8) are incorporated directly within the transient A/C model so that transient performance and optimization results can be tailored to each unique set of driving conditions.

Figure 6 shows a schematic diagram of the transient model of the nominal representative A/C system. Figure 7 shows a schematic diagram of the cabin thermal-hydraulic model embedded within the A/C model. The A/C model consists of a nominal compressor, a nominal condenser design (heat exchanger HX 3000), a nominal orifice tube expansion device, and a nominal evaporator design (heat exchanger HX 6000). Thermal regeneration is included between the orifice tube and the suction line.

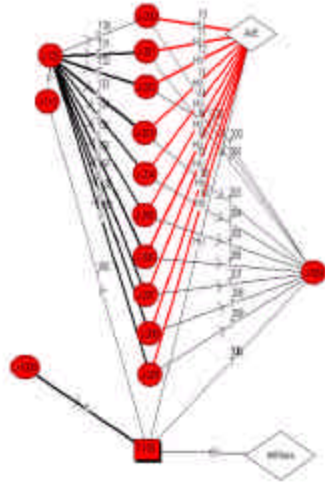

Figure 7. Schematic Diagram of the SINDA/FLUINT Cabin Thermal-Hydraulic Model

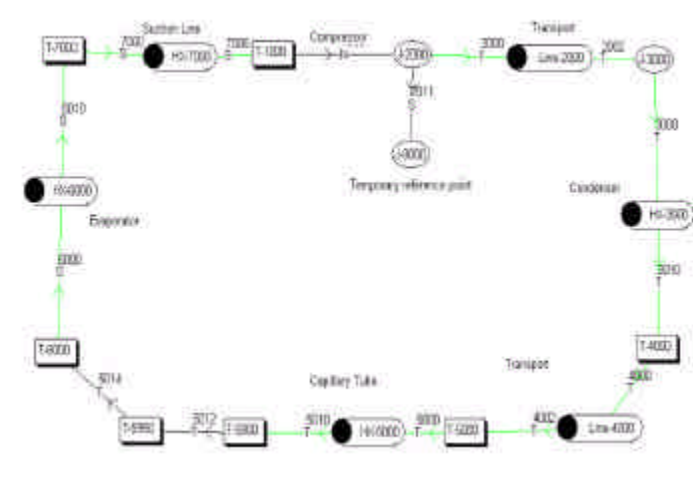

Figure 6. Schematic Diagram of SINDA/FLUINT Transient Air Conditioning System Model

The compressor is characterized by a compressor displacement (D) of 0.0002 m^3 and representative isentropic and volumetric efficiencies. The compressor isentropic efficiency (η_i) and volumetric efficiency (η_v) are characterized by the following relationships with respect to the pressure

ratio (P_r) and the compressor speed (R), respectively:

$$\eta_i = 1 - \left(\frac{A_0}{P_r R} + \frac{A_1}{P_r} + \frac{A_2}{R} + \frac{A_3 R}{P_r} + A_4 + \frac{A_5 P_r}{R} \right)$$

$$\eta_v = 1 - \left(\frac{B_0}{R} + B_1 + \frac{B_2 P_r}{R} + B_3 R + B_4 P_r \right)$$

where the nine constants A_0 through B_4 are curve fit coefficients that represent the compressor map for a specific compressor.

The condenser heat exchanger is a serpentine-type design with 6 serpentine passes, 10 parallel channels, a tube diameter of 0.22 inch, and a weight of 11 lb_m. The evaporator heat exchanger is also a serpentine-type design with 12 serpentine passes, a tube diameter of 0.0625 inch, and a weight of 6.6 lb_m. The heat exchangers are typical of designs shown in Kargilis (Ref 9). Optimizations of various system component design parameters, such as condenser design parameters, transfer line diameters, evaporator design parameters and suction line diameters, is discussed by Hendricks (Ref 8) in the conference proceedings.

Figure 8 through 10 show typical performance predictions from NREL's transient A/C plus cabin model during the SC03 drive cycle after a vehicle hot soak period. Recent NREL tests in Phoenix region showed the vehicle cabin can reach 167°F or higher, so this was the initial boundary condition selected for this simulation. The compressor power in Figure 8 was normalized by the average compressor power over the SC03 drive cycle. The variation in compressor power is quite substantial and indicative of the systems response to compressor speed variations during the SC03. Figure 10 shows the average cabin air and panel temperature cool-down during the SC03. The slow cool-down of both parameters is still in progress at the end of the SC03 after initial steeper declines in the first few minutes.

CONCLUSIONS

The desire to further reduce emissions and increase fuel economy is leading to changes in the ways automotive climate control systems are being designed. There is an increased emphasis on dynamic simulations rather than designing for peak steady-state conditions.

The resulting demand for dynamic modeling of vapor compression cycles leads to a requirement for a next generation of analytic solutions. Prior methods are inadequate because of the intimate coupling of two-phase heat transfer, fluid flow, and thermodynamics required to successfully simulate these units under transient conditions.

General-purpose thermohydraulic software is available and has been demonstrated to offer an answer to this problem.

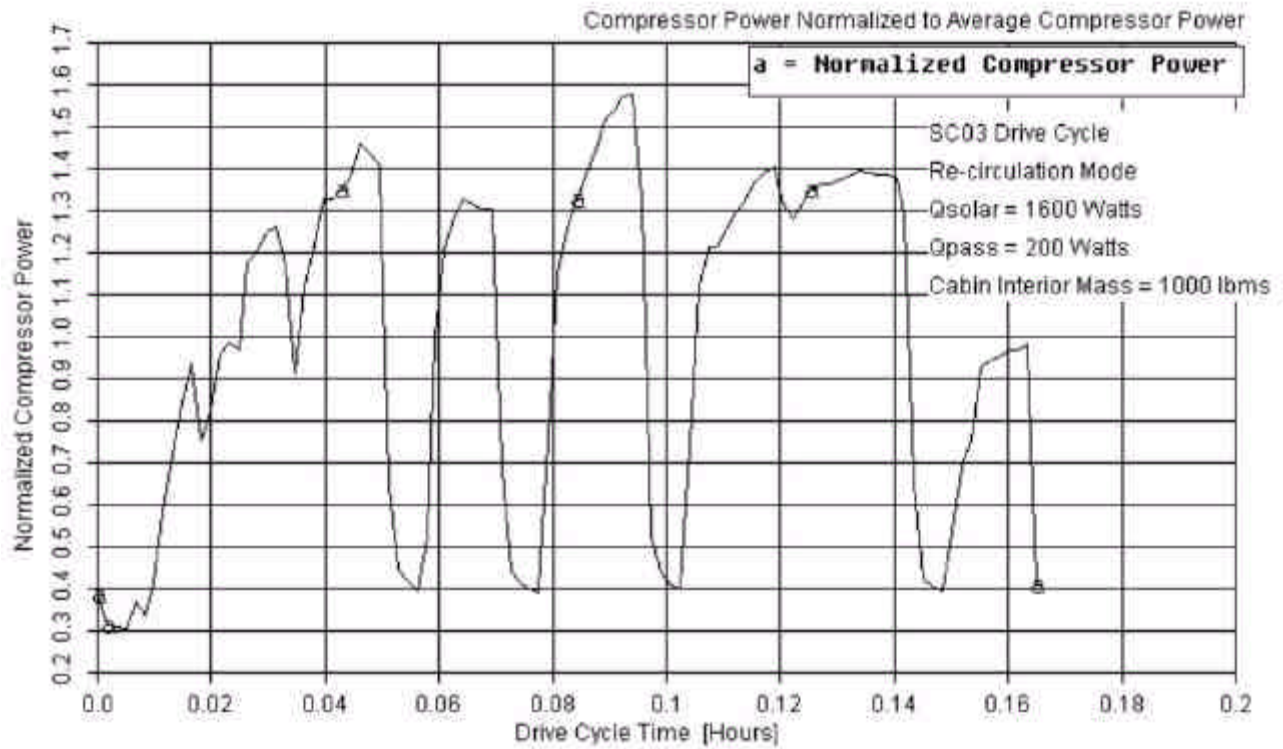

Figure 8. Normalized Compressor Power Prediction During SC03 Drive Cycle After Cabin Hot Soak Conditions to 167°F

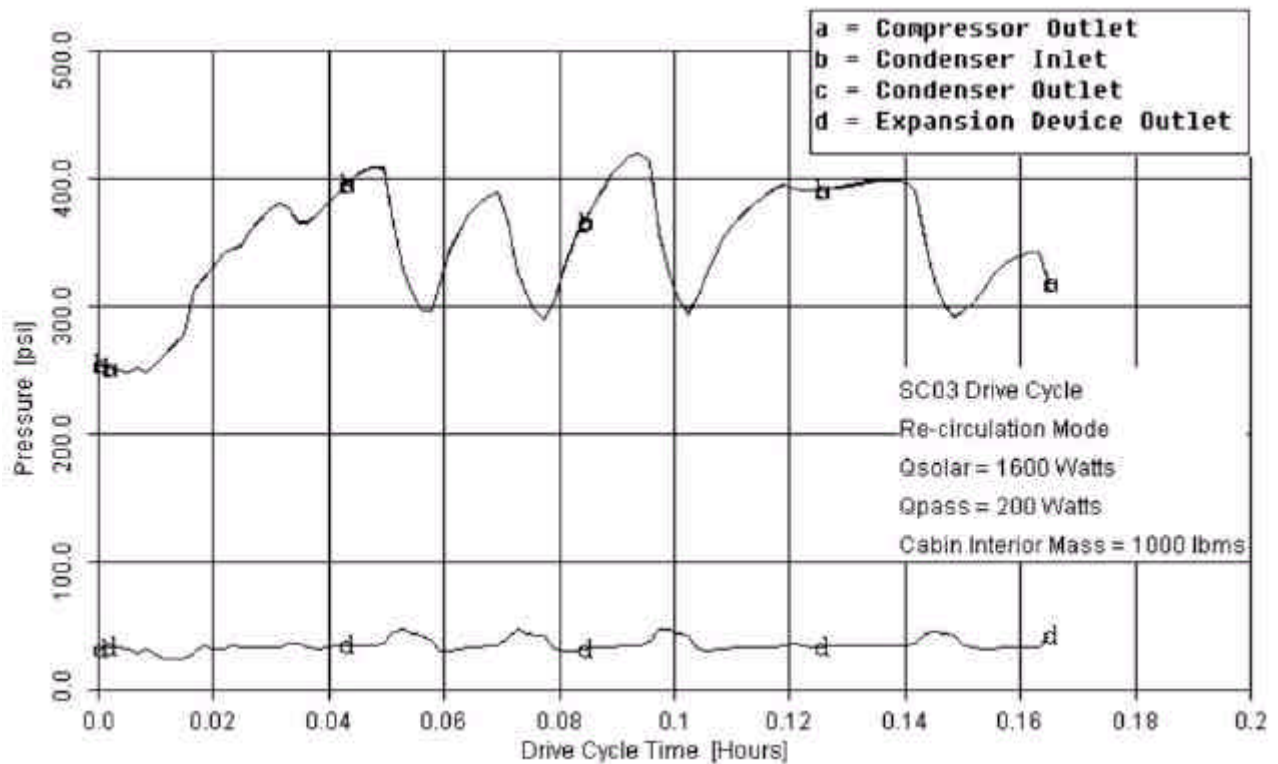

Figure 9. System Pressure Prediction During SC03 Drive Cycle After Cabin Hot Soak Conditions to 167°F.

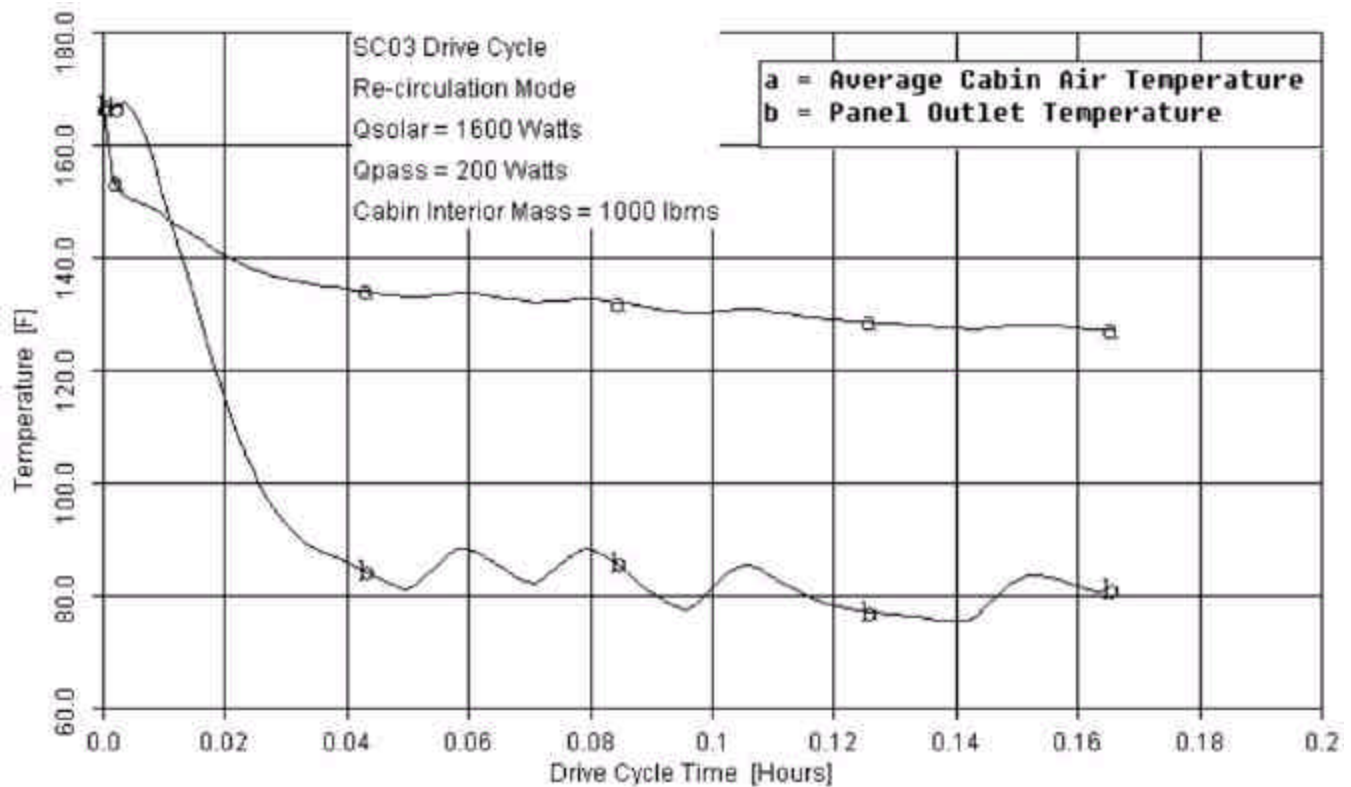

Figure 10. Typical Cabin Temperature Cool-Down Prediction During SC03 Drive Cycle After Cabin Hot Soak Conditions to 167°F

CONTACT

Mr. Cullimore is a co-founder of C&R Technologies, Inc. (www.crtech.com). He earned an MSME degree from Stanford University in 1983, and has 17 years of experience in thermal/fluid system design and modeling. He may be reached at brent@crtech.com or 303-971-0292

Dr. Hendricks earned his Ph.D. from the University of Texas at Austin in 1993 and has 18 years of professional experience in heat transfer, fluid dynamics, and energy conversion systems. He is a senior member of the Center for Transportation Technologies & Systems at the National Renewable Energy Laboratory, Golden, CO (www.ctts.nrel.gov), where he leads up initiatives in advanced cooling/heating systems, advanced HVAC systems, energy recovery, and thermal/fluid system miniaturization. He can be contacted at terry_hendricks@nrel.gov or 303-275-4419.

REFERENCES

1. Bevilacqua, O.M., "Effect of Air Conditioning on Regulated Emissions for In-Use Vehicles", Clean Air Vehicle Technology Center, Oakland, CA, Phase I Final Report Prepared for Coordinating Research Council, Inc., Atlanta, GA, CRC Project E-37, October 1999.
2. SINDA/FLUINT Version 4.3 User's Manual, www.crtech.com/download.html#docs
3. NIST REFPROP, www.nist.gov/srd/nist23.htm
4. Ploug-Sorensen, L. et al; "Improvements in the Modeling and

Simulation of refrigeration Systems: Aerospace Tools Applied to the Domestic Refrigerator;" Danfoss Department of Control Engineering, Corporate Technology and Research.

5. Cullimore, B; "Reliability Engineering and Robust Design: New Methods for Thermal/Fluid Engineering;" C&R White Paper, www.crtech.com, March 2000.
6. Cullimore, B; "Optimization, Data Correlation, and Parametric Analysis Features in SINDA/FLUINT;" SAE-981574.
7. Bursik et al, NASA TM 78810.
8. Hendricks, T. J., "Optimization of Vehicle Air Conditioning Systems Using Transient Air Conditioning Performance Analysis", Proceedings of the Vehicle Thermal Management Systems 5 Conference, Paper # 01VTMS-037, Nashville, TN, May 2001.
9. Kargilis, A., "Design & Development of Automotive Air Conditioning Systems", Course Textbook, University Consortium for Continuing Education, Encino, CA, www.ucce.edu, February 2000.